



DW-KL

Multi-application double-wall exhaust duct & chimney system suitable for high pressure and temperature

www.jeremias.de/int



Page 2

Jeremias Group
STRONG, OPEN,
INTERNATIONAL GROUP

Page 3

Jeremias Group
SERVICE, QUALITY
AND INNOVATION

Page 4

Jeremias Group
QUALITY AND RESOURCES /
TECHNICAL SUPPORT

Page 5

Jeremias Group
SYSTEM APPLICATIONS

Page 6

DW-KL
PRODUCT OVERVIEW

Page 7

DW-KL
SYSTEM DESCRIPTION

Page 8-9

DW-KL
BELLOWS & SILENCERS

Page 10-13

DW-KL
TECHNICAL DATA

Page 14-15

DW-KL
ASSEMBLY & QUALITY

Page 16-17

DW-KL
INSTALLING
INSTRUCTIONS

STRONG, OPEN, INTERNATIONAL GROUP

The **Jeremias Group** has more than

40 years experience

in the flue and chimney production.

The headquarters are situated in Germany. The Jeremias Group has expanded its activities steadily in Europe being now the single stainless steel chimney manufacturer with

8 production locations
in 7 different countries.

Besides production and own sales offices, Jeremias has strong cooperation partnerships with chimney specialist companies all over Europe.

Jeremias is one of the world's leading manufacturers of flue and chimney systems for the exhaust of gases and ventilation, covering all kind of domestic, commercial and industrial applications. Jeremias product range include

100 different CE certified systems

covering commercial and domestic applications complemented by freestanding Industrial steel chimneys up to 4 meter diameter.

Jeremias offers its clients a wide range of high quality products, technical support for projects, chimney sizing software, European CE certification in a modern and dynamic company able to satisfy a wide variety of the flue market requirements needed in the market.





Page 18-21

DW-KL
CASE STUDIES

Page 22

DW-KL
MOUNTING HEIGHT
OF THE SYSTEM

Page 23

DW-KL
OFFSETS & ANGLES

Page 24-25

DW-KL
CONFORMITY
DECLARATION CE

Page 26-27

DW-KL

SERVICE

- > Flexible production line
- > Total flexibility for special parts (customization)
- > Design of project drawings
- > Chimney sizing
- > Test-capable chimney static calculations
- > Biggest product range in the market
- > Development for market-focused system solutions
- > Country specific certifications and installation advice

QUALITY

- > CNC Laser technology
- > CNC stamping technology
- > Modern 3D CAD software
- > Special stainless steel alloys
- > 3D laser cutting

INNOVATION

- > System development with boiler, CHP and stove manufacturers
- > Own specific machine development
- > Own test laboratory for acoustic R&I silencer development



QUALITY AND RESOURCES

Manufactured in accordance with the EN 1856-1 (performance requirements for metal chimney systems) and under quality assurance EN ISO 9001:2000.

Jeremias products have achieved designations for all normal applications, in domestic, commercial and industrial projects.

Besides this compulsory CE certification, Jeremias has also special certifications and listings needed in specific countries under i.e.: BS, Hetas, Swiss, Russian or US standards.

For further information, Jeremias can supply technical guidance on various standards including the latest version of the European standard 1856-1:2010. Please contact our certification department.

TECHNICAL SUPPORT

- > Chimney sizing
- > Fire rating advice
- > Mechanically controlled ventilation calculation
- > Design and system recommendation
- > Structural design and test-capable chimney static calculations
- > Supply and install service (own installers, or via accredited specialists)
- > After sales service
- > Product warranty



SYSTEM APPLICATIONS



CHIMNEY SYSTEMS

- > Heating and hot water
- > Chimney relining systems
- > Concentric balance flue systems
- > Shared collective chimney systems CLV
- > Plastic relining systems
- > Fan dilution / fan assisted systems
- > Freestanding chimneys
- > Mast supported chimneys
- > Windshield chimneys



EXHAUST SYSTEMS

- > Generator / turbine exhausts
- > Cogeneration / CHP
- > Incinerator exhausts
- > Industrial process exhausts
- > Engine exhausts
- > Dry oven exhaust
- > Kitchen exhausts
- > Micro-cogeneration



SMOKE EXTRACT SYSTEMS

- > Fire rated smoke ducts to BS 476 pt 20 (4 hours)
- > Fire rated ventilation ducts to UNE-EN 13501
- > Laundry / refuse chutes



VENTILATION

- > Free standing ventilation towers
- > Fire rated ventilation ducts
- > Mechanically controlled ventilation systems

TWIN WALL INSULATED FLUE SYSTEM SPECIALLY DESIGNED FOR GENERATOR EXHAUST

DW-KL is a multifunctional, twin wall insulated stainless steel flue system especially designed for high temperatures, high pressure and condensing.

Its main characteristic is that no sealing material is used but a permanent connection is established through a metal to metal joint without any gaskets, a so-called conical system.

Because of these features it is the only all purpose product in the chimney industry.



FIELDS OF APPLICATION:

- > **Generator exhaust**
High temperature exhaust gases and pressure
- > **CHP**
Combined heat and power
- > **Smoke extract**
Fire rated smoke extract
- > **Waste gas extract**
Industrial process exhaust
- > **Kitchen extract**
Catering / kitchen extract duct
- > **Light weight particle movement**
Blown particles for manufacturing plants
- > **Fire rated ducting**
Enabling multiple fire compartments to be used
- > **Refuse / laundry chutes**
Flats, hotels, hospitals
- > **Boilers**
Condensing and high temperature boilers
- > **Chemical exhaust**
Painting and printing industries
- > **Drying ovens**
Automotive industry
- > **Food processing plants**
Catering industry, convenience food
- > **Incinerators**
Using specialist alloys to prevent corrosion
- > **Condensing boilers**
No need of gaskets

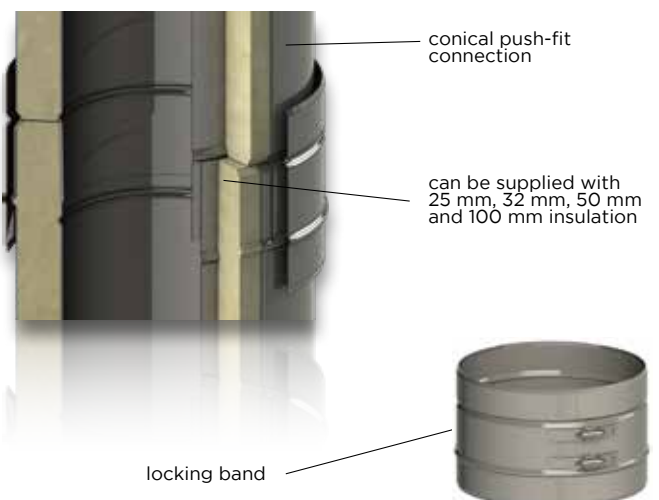

EASE OF HANDLING

The double wall Jeremias systems are known for ease of handling and therefore quick installation times. The DW-KL system is designed to be used as an **alternative to conventional heavy gauge welded steel**. By comparison to these other materials, it is more easily and economically installed. The DW-KL system is available in 14 standard-sizes **between 80mm and 600mm** (4" to 24") internal diameter. Larger diameters are available up to 1200mm.

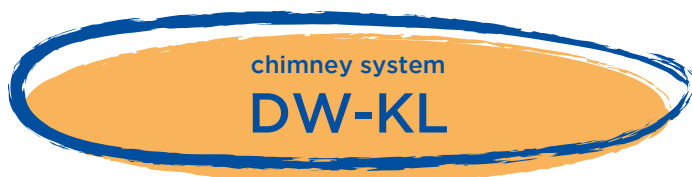

CONNECTION

The connection between **components is conical and metal**. This guarantees a **fast and easy installation** (no flanges, no gaskets) and ensures tightness for all temperatures. The metal joint is the best connection for a **tight long-life**. Every component has to be mounted so that the **nozzle of the interior pipe** is above or rather in the flow direction of the exhaust gas. Joint security is protected by a **locking band**.

INSULATION QUALITY

DW-KL double wall insulated system uses rigid mineral wool with high density (120kg/m³). **Standard thickness** is **32mm** and **50mm**. Greater thicknesses are available on request. The special insulation quality and the homogeneity ensure low surface temperatures of pipe and also maintains the exhaust gas temperatures while enabling the ease of installation. The insulating material between the inner and outer walls is **pressed very tightly**. Because of this construction the heat transfer to the outer casing is greatly reduced as there is **no metal contact (thermal bridge)** between the inner gas carrying pipe and the outer wall. DW-KL system has **excellent acoustic properties** due to the density of the insulation.

TEMPERATURE

DW-KL is suitable for a continuous flue gas operating temperature of 600°C, (in accordance to EN 1856-1) using different kinds of stainless steel and insulation **temperatures up to 1050°C** can be achieved.

PRESSURE

The DW-KL system is **certified up to 5000 Pa** for positive pressure (in accordance to EN 1856-1) and **suitable up to 15000 Pa**. It has been successfully tested for negative pressure of 3000 Pa.

MATERIAL

The **inner liner**, which has contact with the exhaust gas, is manufactured of stainless steel with the material number **1.4571 (316Ti) / 1.4404 (316L)**. All longitudinal seams are **TIG or laser gas shield welded** and passivated. Thus the highest possible corrosion resistance is available. The standard **DW-KL inner liner** is made of **0.6mm** wall thickness or as an option up to 1.0mm on request. The standard **DW-KL outer liner** is made of **1.4301 (AISI 304)** bright finished (IIID). Other finishes can be supplied on request, e.g. mat, brushed, zinc, painted or copper covered. In **aggressive atmosphere** it is recommended to use stainless steel **1.4404 (AISI 316L)**.

BELLOWS AND SILENCERS



THERMAL EXPANSION



As the method of assembly for DW-KL provides a continuous inner wall, expansion of the vent should be allowed above 350°C. DW-KL provides tightness in the inner liner and is therefore suitable also in wet conditions (condensing applications in high pressure).

Any length of duct where expansion is likely to exceed 6 mm between two fixed points, i.e. boiler outlet and elbow, wall supports, etc. must incorporate an expansion component (bellows) to compensate for thermal movement.

As a general rule to calculate the liner expansion you have to take 1mm per metre and 50°C rise of gas temperature.

For example:

A 25 metre run of DW-KL subjected to a flue gas temperature of 470°C above ambient.

$$1 \times 25 \times 470 / 50 = 235 \text{ mm}$$

Use bellows to accommodate the total expansion between fixed points.

The outer casing is free to expand independently of the inner liner.

Floor and wall bands must be located to allow for lateral movement. Our expansion bellows can accommodate thermal expansion up to 120mm.

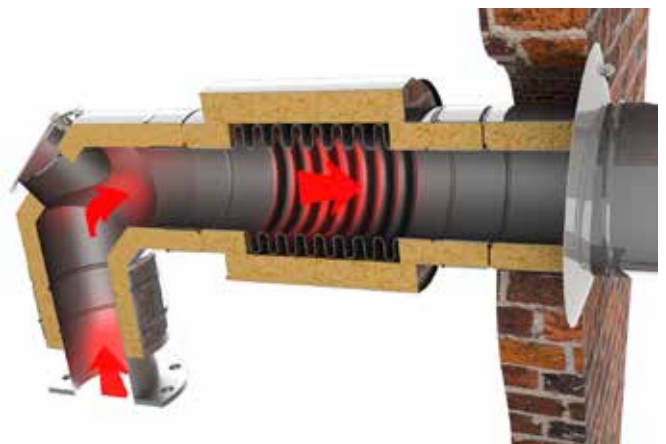

Therefore, total expansion which needs to be accommodated for this example is 235 mm.

Lineare Wärmeausdehnung
1.4404 / 316L

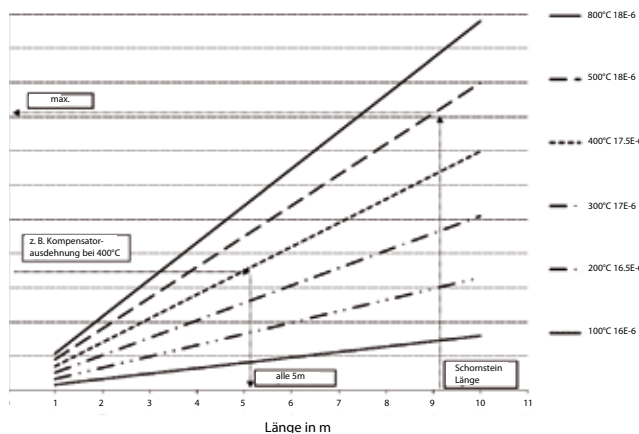

NOISE REDUCTION



With the DW-KL system we can also provide a wide range of different silencers depending on the application field:

- > Absorption silencer for wet and dry conditions for different sound level reduction categories
- > Absorption silencers in angle- or T-design if there is not much place for installation
- > Absorption cores for additional sound reduction, to be placed in the chimney
- > Combined silencer with resonance and absorption chambers for damping a wide acoustic spectrum
- > Head silencer for installation at the top of the chimney
- > We create non-standard products for any special requirement

To keep the required noise level, there are cases where we can reduce the diameter installing a silencer at the end of the system.

ABSORPTION SILENCERS

ASD-H

Exhaust silencer for wet operation mode for small CHPs, high positive pressure

COMBINED SILENCERS

ZUTE.805

Combined exhaust silencer with absorption and resonance chambers for small and medium-sized block heating stations for a wide frequency spectrum, wet and dry operation mode

ZUTE.783

Combined exhaust silencer with absorption and resonance chambers for small and medium-sized block heating stations, wet and dry operation mode, with radial inflow

INSERTION SILENCERS / TOP-MOUNTED SILENCERS

SDK

Sound absorbing insert to be hinged into the top part of the chimney for an easy conversion into existing chimneys, for medium and high frequencies

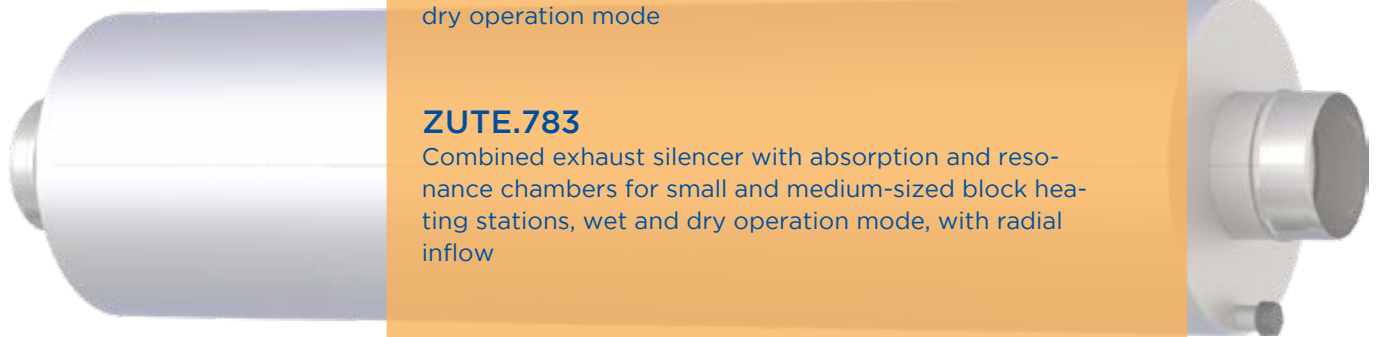

Please contact our technical department for further information on special constructions etc.

TECHNICAL DATA

GENERAL

APPLICATION

Double wall pressure-resistant flue gas system (resistant to 5000 Pa) made of stainless steel for all standard furnaces, combustion-engines and CHP appliances in negative, positive- and high-pressure for dry and moist operation mode.

COMBUSTIBLE

oil, gas and solid fuels

WORKING TEMPERATURE

≤ 400°C / ≤ 600°C

MATERIAL

inside: 1.4571 (316Ti) / 1.4404 (316L)

outside: 1.4301 (304)

WALL THICKNESS

inside: 0,6 (also available from < 0,6 - 1,0mm)

outside: 0,6 (also available from < 0,6 - 1,0mm)

WELDING SEAM

TIG continuous / laser

INSULATION

mineral insulation with 32 mm wall thickness, bulk density 120 kg/m³

CONNECTION

negative / positive pressure with conical connection

POSITIVE PRESSURE

200 Pa / 5000 Pa

SOOT FIRE RESISTANT

see CE designations (G)

FREE STANDING EXTENSION

3 m up to last wall spacer to Ø 600

1,5 m up to last wall spacer > Ø 600 - 1.000

THERMAL RESISTANCE

0,501 m² K/W

ADMISSION / ASSESSMENTS

DW-KL - EXHAUST SYSTEM

(N) CE mark number

0036 CPD 9174 002

CE classifications DIN EN 1856 - 1

DW-KL - CONNECTING PIPE

CE mark number

0036 CPD 9174 041

CE classifications DIN EN 1856 - 2

T600 - N1 - D - V3 - L50060 - G100

T600 - H1 - W - V2 - L50060 - G100

Application

The system DW-KL can be used for the evacuation of exhaust gases from all oil- gas and solid fuel-fired furnaces in negative and positive pressure operation mode (5000 Pa) with a maximum temperature of 600°C.

CHPs

The system DW-KL can be connected to block heat stations with flanges.

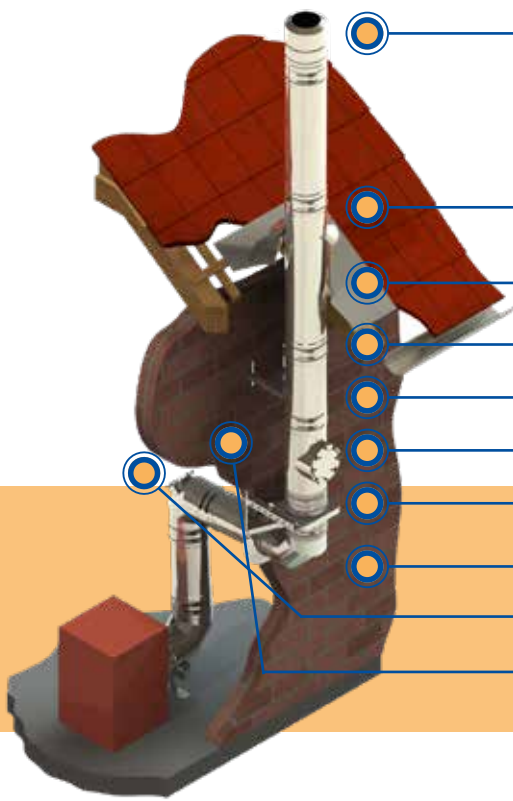

DW-KL - CHIMNEY

- end cap / termination (DWKL32)
- flashing kit (DW83)
- length 1000 mm (DWKL13)
- clamp fitting (DW41)
- wall bracket, static 50 mm (DW45)
- length with clean-out opening (DWKL10HT)
- base plate for intermediate support (DWKL07)
- bend 87° static (DWKL64)
- bend 90° with clean-out opening (DWKL19HT)
- wall support & cross rail (DW391)

DW-KL - CONNECTING PIPE

- bend 87° up to 600°C / 5000 Pa (DWKH.927)
- length 500 mm (DWKH.014)
- bend 90° with clean-out opening (DWKL19)

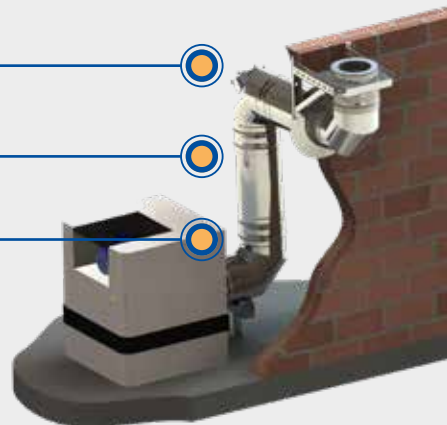

MINIMUM SPACE AND SIZE RATIO



MINIMUM SPACE TO COMBUSTIBLE MATERIALS IN THE UPRIGHT PART

On application of the vent line a minimum dimension of 20 mm at 400 °C or 50 mm at 600 °C has to be kept. Up to a maximum thermal resistance of 2,5² k/w of the close-by flammable component a minimum dimension of 50 mm, measured on the outer layer of the exhaust gas system. If the thermal resistance of the close-by flammable component (eg. at high-thermal insulated framehouse) exceeds 2,5 m² k/w, the light space has to be recalculated. If the value is not exceeded, the below listed values are valid. At wall penetration the state building codes are valid.

	DW-KL	minimum space
DW 400	✓	xx ≥ 50 mm at 400 °C
DW 400 FU	✓	xx ≥ 20 mm at 400 °C
DW 600 FU P1	✓	xx ≥ 20 mm at 600 °C
DW 600 N1	✓	xx ≥ 50 mm at 600 °C
DW 600 FU H1	✓	xx ≥ 50 mm at 600 °C

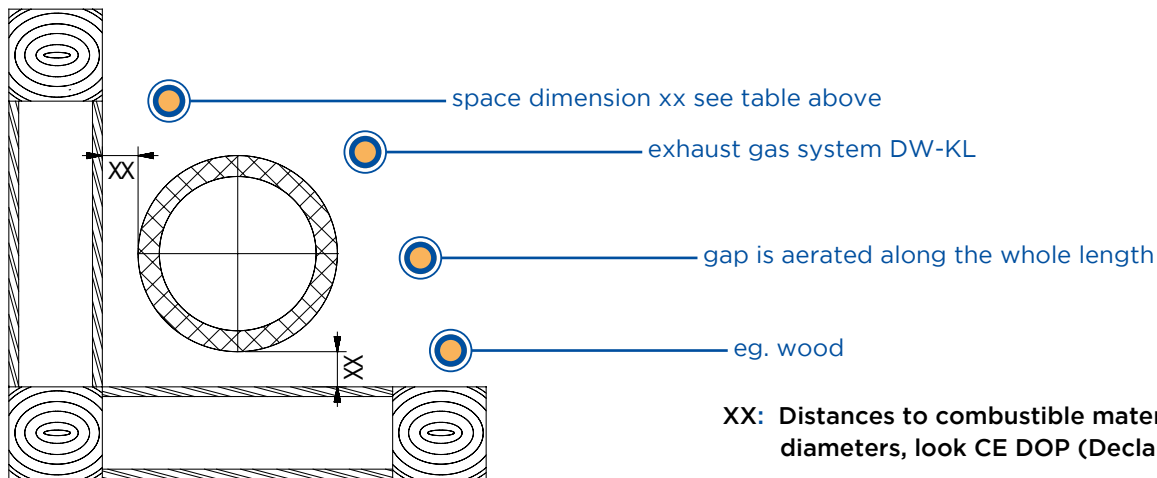

For further space regulations see national building regulations (eg. in Germany DIN V 18160-1).





MINIMUM SPACE TO COMBUSTIBLE MATERIALS IN THE UPRIGHT PART

If the exhaust gas system is to be moved, the maximum dimensions of the following drawing should be observed.

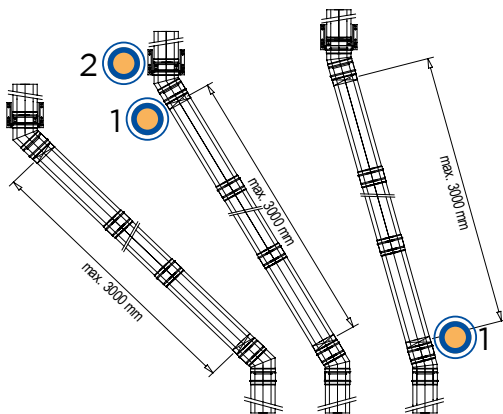

INCLINED RUN 15° / 30° / 45°



Please observe that the clean-out openings have to be according to the national regulations.

INCLINED RUN 87°



- 1  Fixing with wall brackets DW 20-24
- 2  Intermediate support and wall support



Which fuel type is the right one for your heating?
For renovation or new construction: the right Jeremias flue system makes it possible.

ASSEMBLY / QUALITY

ASSEMBLY

Assembly is accomplished in five easy stages.

1. Having ensured that the conical joining parts are **clean and not damaged**, apply our **KL lubricant paste to the male conical pipe** normally at the bottom end of the pipe and **bring** the two conical joints **together**.
2. **Insert the male joint** into the female of the two elements.
3. Loosely **push** the two pipes **together**.
4. **Tap the top pipe** to ensure correct seating of the joint while ensuring that you do not damage the pipe you are tapping. **Light tapping** with a rubber, nylon or wooden headed mallet.
5. **Fit locking band**.

The integrity of the joint between components is dependent upon the correct use of these instructions.



Expansion bellow

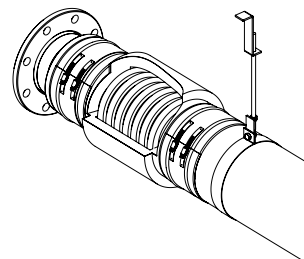



Horizontal exhaust terminal

QUALITY

QUALITY ASSURANCE

ISO 9001:2008 certification 12 100 2120 1

Length

Expansion bellow

Wall support & cross rail

Tee

Length with clean-out opening

Wall support & cross rail

INSTALLING INSTRUCTIONS

DW-KL “PUSH AND FIT”

The different components of the DW-KL system have to be connected together by using the fitting paste. Lubricate both ends, push them together knocking lightly with the help of a board and a hammer and fit with the locking band.

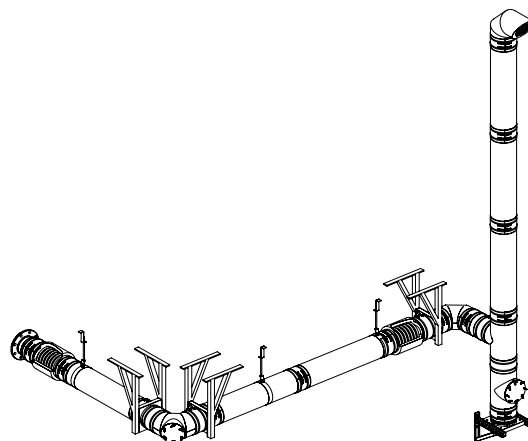

CONNECTING PIPE / HORIZONTAL RUN

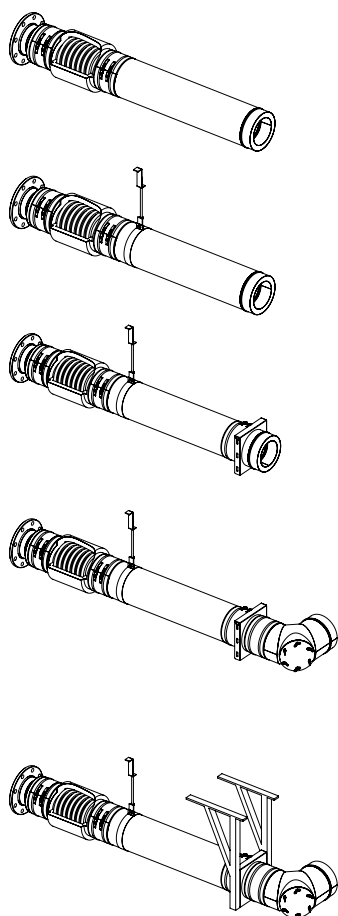

1. Connect the appliance flange outlet to the **DW-KL system flange** using the necessary joint. For specific flange connections please contact our technical support.
2. In the case that an **expansion bellow** is necessary, install it on an accessible place on the connection flue to the system. Please remember, as a general rule, that the expansion below has to be installed in between two fixed points.
3. Install all the **necessary lengths** till the next fixing point.
4. In the horizontal run, use **hanging brackets** every three meters.
5. Always use a **fixing point** before a bend.
6. Install the **90° bend** with “integrated installing device” at the end of the connecting pipe and push it to the system knocking lightly with the help of a board and a hammer. (specific drawing is necessary)
7. It is now when you can definitely fix the support to the ceiling, wall or steel structure. It is recommended to use the supports (DW01) and brackets (DW391).

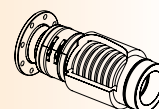

VERTICAL CHIMNEY

8. Use **another fixing point** after the bend and fix it with the help of appropriate supports to the ceiling, wall or steel structure.
9. The **number of the expansion bellows** necessary to compensate the expansion of each particular system has to be calculated and it depends on the length of the horizontal run and the smoke temperature inside the system.
10. Please be sure you keep a **proper maintenance** of the system in order to avoid impurities from the combustion that could damage the waves of the bellows and therefore the correct length compensation.
11. Every expansion bellow needs a **fixing point** after it to contain the expansion.
12. Calculate the **height of the connection** to the T branch and fix the wall support, there are many ways to support the vertical chimney, please see different supports and brackets in the component list.
13. We recommend the installation of **inspection elements** with door in order to access to the cleaning of the system. In many European countries the use of a clean out opening is compulsory. Please revise your national legislations and local authority's building regulations.
14. Verify the **correct fitting** of the lengths and locking bands. The locking band has two parallel beadings, one to the inside and one to the outside. These two beadings have to match **exactly to the lengths**.(detailed photo) Once the beadings match together fix the locking band with the two hose dips, we recommend the use of an automatic screwdriver.
15. All the **brackets** are designed for the lateral stability of the system and not for supporting the system. Please see the tables with the distances between brackets, supports and offsets.

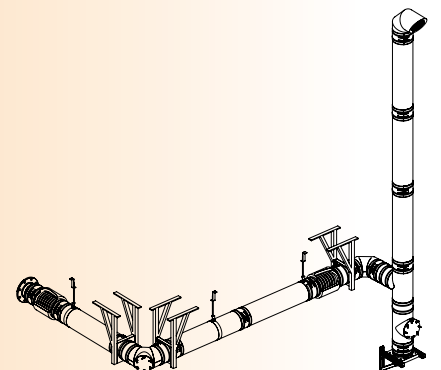
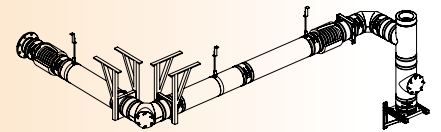
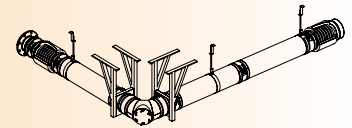
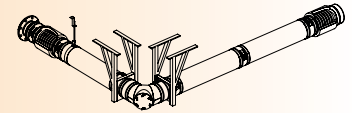
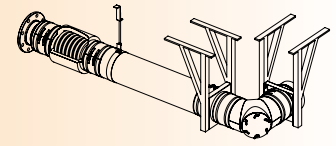

CASE STUDIES

BMW - MUNICH / GERMANY

APPLICATION:
INDUSTRIAL SMOKE EXHAUST

DIAMETER:
Ø 200 - 550 mm

LENGTH:
2.260 m (39 SYSTEMS)

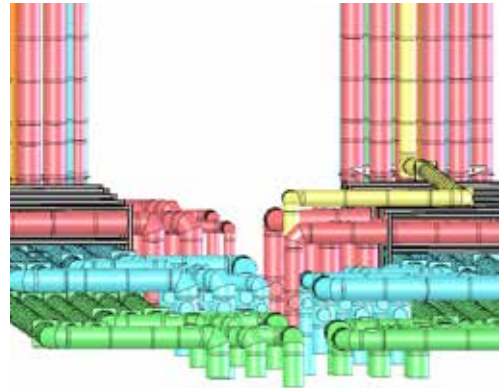

With the BMW project Jeremias has demonstrated how to solve specific requirements for industry, developing new items and special parts in coordination with the installing company and the final client.

39 engine exhaust test cells are evacuated individually; all the exhausts are put together into a mast supported riser. The positive pressure of 5000 Pa and the smoke temperature were the handicaps for this installation, DW-KL was the solution.

Another example of how an industrial project can be integrated in the urban scenario like a piece of art.



Jeremias has developed a lot of market-typical system parts. Please contact your local Jeremias partner to receive a detailed consultation on our market specific solutions.

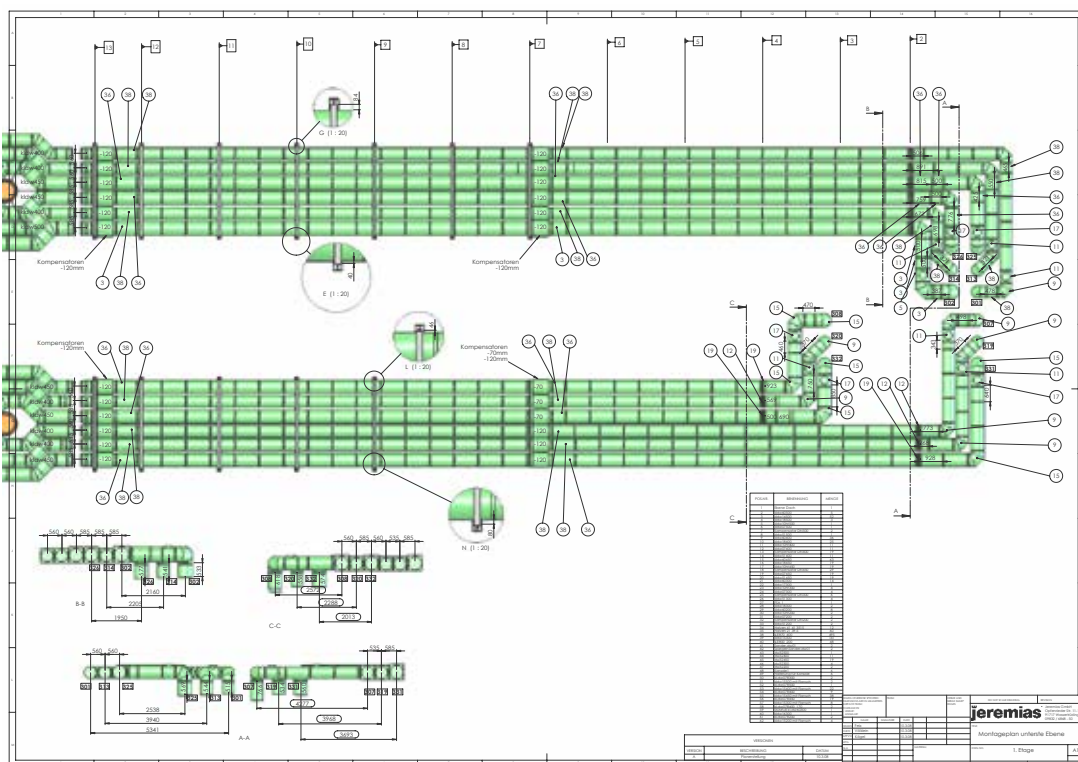

ENERGY CENTER SCHLANDERS / ITALY

APPLICATION:
WOOD CHIP GASIFICATION, CHP
(BODIESEL, BIOGAS)

DIAMETER:
Ø 200, 250 & 350 mm

LENGTH:
108 m (3 SYSTEMS)

The Jeremias project has provided the exhaust system for a high technology green electricity plant based in Schlanders, a village in the north Italian region of Trentino Alto Adige, together with Dr.-Ing. Lothar Peintner.

A high technology synthesis gas generator uses microwave and plasma technology to produce fuel gas with high hydrogen content using wood chips as a combustible source.

This high hydrogen content gas is used to generate combined heat and power. The performance of the plant is about **220 kW** electricity power and **500 kW** thermal output.

In addition the energy plant is completed by the installation of a biodiesel engine with a net electrical output of about **250 kW** and a thermal output of **290 kW**.

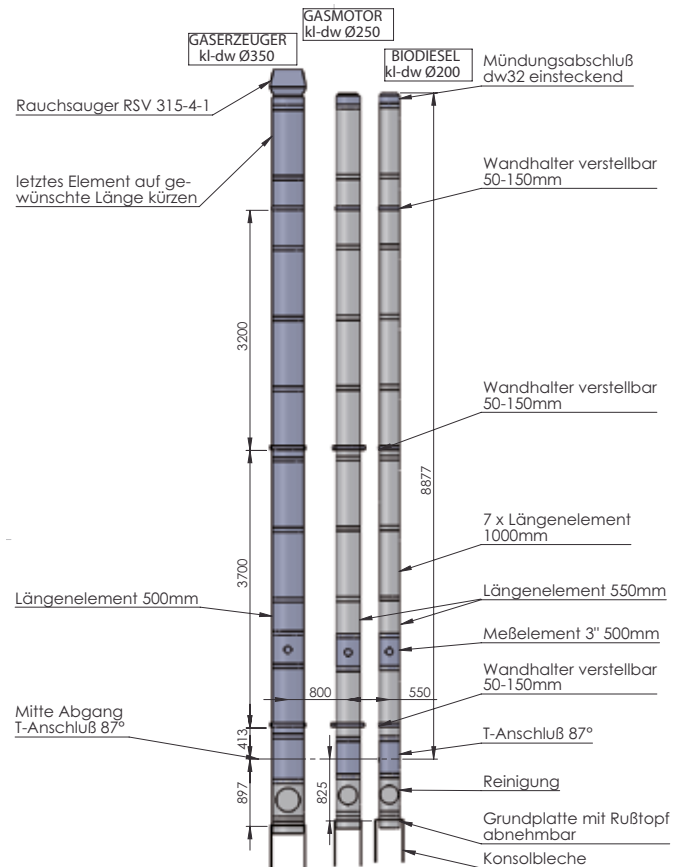

In the Jeremias product-portfolio we have standard systems for applications and we have the capacity and experience to design the modifications or adapt our systems to special applications.

Gasifying of wood chips with flue gas temperatures of **900°C** creates special demands on material - in flue liner and insulation. This was solved by Jeremias with DW-KL, high temperature steel and ceramic fibre insulation to protect health and environment.

Flue ducting with long expansions caused by high temperature requires special technical design.

DW-KL is developed to absorb these expansions with bellows.

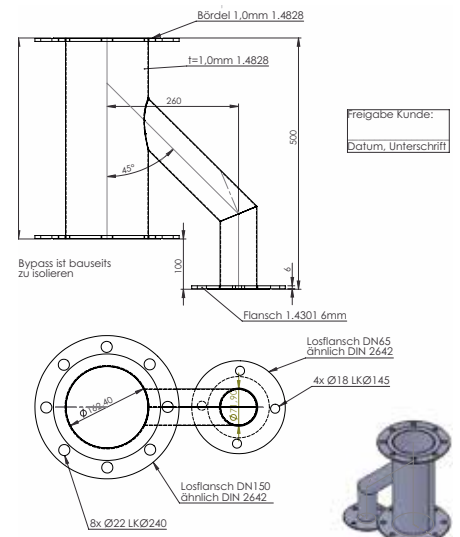
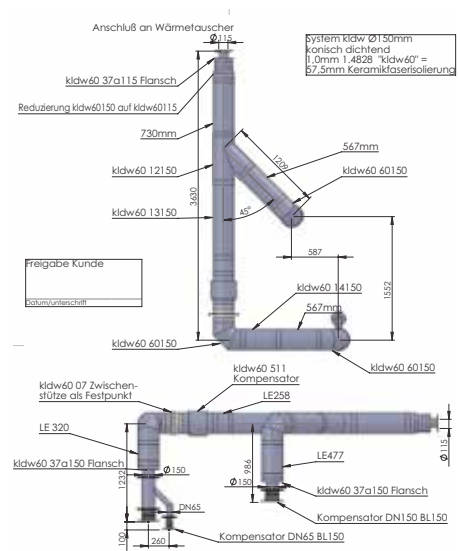

MOUNTING HEIGHT OF THE SYSTEM

Jeremias provides **technical advice** for system application and size calculation. All the flue size calculations done by our technicians are in accordance with the requirements defined at the EN 13384-1 (single appliances) and EN 13384-2 (multi appliances) standards.

Jeremias provides the **necessary reports** for these calculations. Please take into account the flue height terminations depend on national, regional or even local authorities. Therefore we recommend you to contact Jeremias at the specific country.

Maximum mounting heights and distances in m

Ø inner [mm]	DW-KL	a		b		c	d
		DW21	DW45	DW21	DW45		
80	✓	4	4	3	3	53	64
100	✓	4	4	3	3	53	64
115	✓	4	4	3	3	53	64
130	✓	4	4	3	3	53	64
150	✓	4	4	3	3	41	60
160	✓	4	4	3	3	40	58
180	✓	4	4	3	3	38	54
200	✓	4	4	3	3	37	49
225	✓	2	4	3	3	35	44
250	✓	2	4	1,5	3	32	39
300	✓	2	4	1,5	3	27	38
350	✓	2	4	1,5	3	24	36
400	✓	2	4	1,5	3	22	35
450	✓	2	4	1,5	3	20	32
500	✓	2	4	1,5	3	16	28
600	✓	2	4	1,5	3	15	21
650	✓	-	4	-	1,5	-	13
700	✓	-	4	-	1,5	-	12
750	✓	-	4	-	1,5	-	12
800	✓	-	4	-	1,5	-	11
850	✓	-	4	-	1,5	-	10
900	✓	-	4	-	1,5	-	10
1000	✓	-	4	-	1,5	-	9

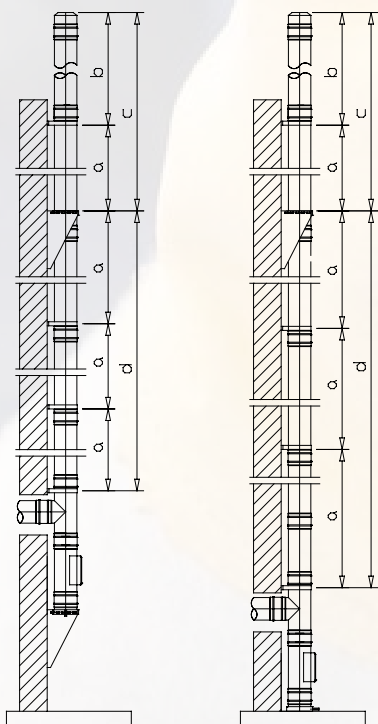

Please take these distances as general reference. Please contact our technical department for exact documentation on weights and installation heights.

CE DECLARATION OF PERFORMANCE (DOP) LARGEST NUMBER OF CE - CERTIFIED SYSTEMS

The **Jeremias group** of companies has been present in the flue industry for **more than 40 years**, and now is the **stainless steel flue systems manufacturer** with the largest number of **CE certified systems**. The CE MARK is the symbol - obligatory since April 2005 - that certifies that a stainless steel chimney is in accordance with the EN 1856-1.

This standard specifies the performance requirements for rigid single and multi-wall system chimney products with metallic liners (chimney sections, chimneys fittings and terminals, including supports) used to convey the products of combustion from appliances to the outside atmosphere.

It also specifies the requirements for marking, manufacturer's instructions, product information and evaluation of conformity of the product to the standard. The EN 1856-1 introduces a requirement for a certified factory production control system, which is in addition to any existing ISO 9001 factory quality scheme. This ensures, through continuous assessment and external quality audits, that the manufactured product conforms with the performance designation of the product.

A simple code will give the user information about the suitability of the system for different applications.

CE Designation: EN 1856-1 T600 N1 V3-L50040 G70

TEMPERATURE CLASS

T80, 100, 120, 140, 160, 200, 250, 300, 400, 450, 600

This indicates the normal maximum operating temperature of the chimney.

PRESSURE CLASS

N1, N2, P1, P2, H1, H2

The pressure class relates to the product's suitability and gas tightness when used on positive pressure applications up to 200 pa (P), negative (N) draught applications, and high positive pressure (H) applications and is further classified as to the degree of leakage allowed with either a 1 or 2, with 1 having the lowest leakage rate.





CONDENSATE RESISTANCE CLASS

W=Wet, D=Dry

CORROSION RESISTANCE

V1, V2, V3, Vm

V1: Sulphur content $\leq 50 \text{ mg/m}^3$, natural gas L+H Kerosene: Sulphur content $\leq 50 \text{ mg/m}^3$.

V2: Natural gas L+H Oil: Sulphur content $\leq 0.2 \text{ mass } \%$
Kerosene: Sulphur content $\geq 50 \text{ mg/m}^3$ wood in open fireplaces.

V3: Natural gas L+H Oil: Sulphur content $> 0.2 \text{ mass } \%$
Kerosene: Sulphur content $\geq 50 \text{ mg/m}^3$ wood in open fireplaces. Wood in closed stoves, coal peat

Vm: Self declared by the manufacturer as suitable for the application based on product history and historical performance in the field. The corrosion resistance class should be matched against the fuel type.

THE LINER SPECIFICATION

The liner specifications offer a number of material codes together with the lowest diameter liner thickness.

SOOT FIRE RESISTANCE

G [X] = with soot fire resistance

O [X] = without soot fire resistance

[X] = product declared minimum distance to combustible material in mm.

The CE mark enables the product to circulate freely in the European market, being the highest standard for metal chimney systems in the world; nevertheless each country could have its own installation rules. Jeremias also has a wide range of specific certifications to enforce national, regional or even local regulations. No matter where the project will be installed, Jeremias will provide the necessary certification to meet the local approvals procedure.

For any specific documentation needed during project specification please contact our technical department.

*Please have a look at our AGBs for detailed regulations.

EXHAUST SYSTEMS FOR YOUR INDUSTRIAL APPLICATIONS

With us, your project is in the best hands! Our experts advise you personally from chimney design and planning right through to the production and assembly of ready-to-install exhaust system.

Together with you, we plan all necessary process steps and consider your individual requirements and wishes.

This is how we develop the optimal chimney solution for your project, making even the most demanding projects run smoothly and successfully.



PERFORMANCE RANGE

Our services cover the following specifications:

Basic evaluation / project planning

- > Definition of plans, site surveying
- > Determination of dimensions of exhaust gas pipes according to DIN 4133 / EN 13084 on the basis of the structural and heating requirements
- > Determination of dimensions of the ventilation towers according to DIN / EN regarding the ventilation technical requirements
- > Preparation of verifiable static calculations according to DIN 4133 / EN 13084 in consideration of the geographical and static specifications on site

Execution of construction work

- > Preparation of execution drawings for release on site
- > Preparation of workshop drawings
- > Delivery according to construction schedule
- > Coordination of installation with site management
- > Complete installation package.

Condition monitoring

- > according to DIN 4133 / EN 13084

STRENGTHS

State-of-the-art machinery, a permanent product control by our own welding specialist engineers, high quality standards as well as flexibility.

DEVELOPMENT

The continuous further development of all of our products is part of our elaborate type series, which meet the increasing demand of ecological awareness (exhaust and sound emissions) as well as high aesthetic demands of our clients.

ENGINEER STANDARDS

Both new installations as well as renovations of existing flue gas-, chimney- or ventilation systems are always carried out in accordance to DIN 4133 / EN 13084 in all parts of Europe.

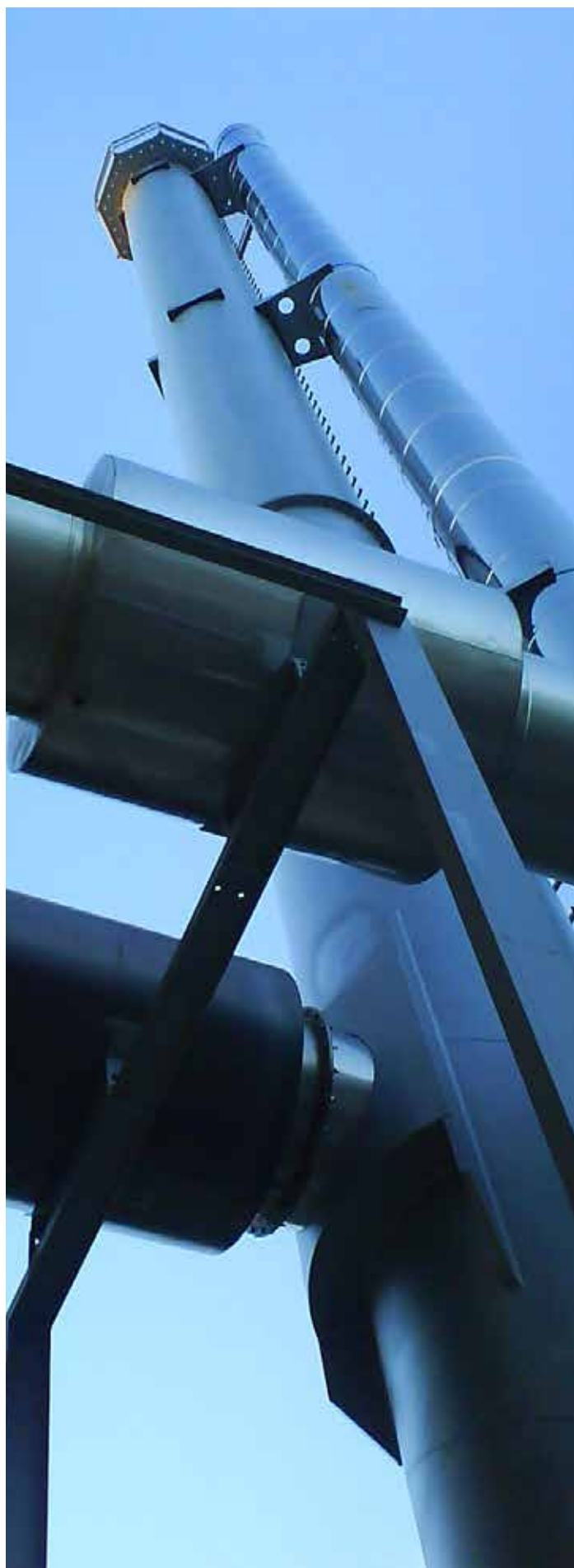
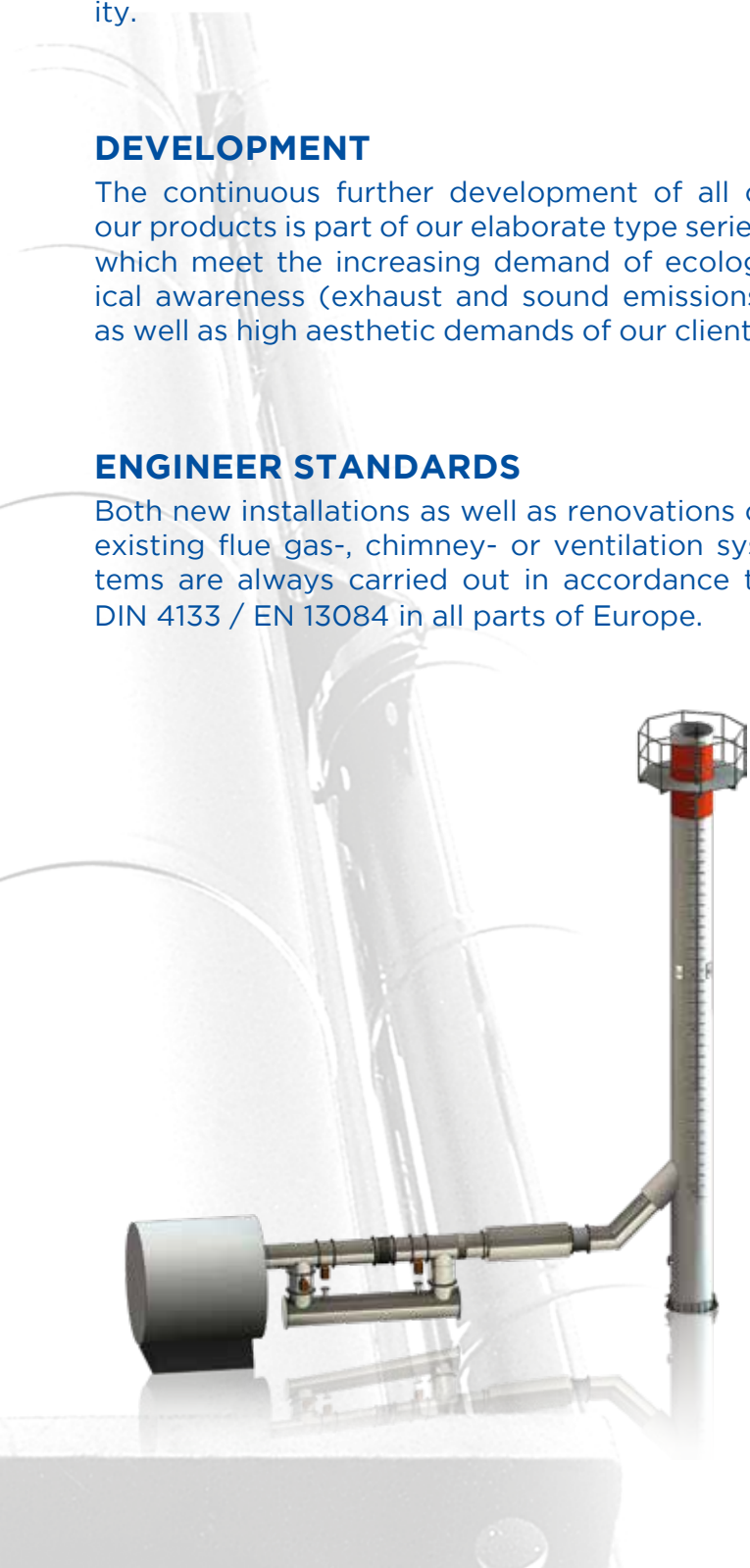

PRODUCTION SITES

GERMANY

Jeremias GmbH
Opfenrieder Str. 11-14
91717 Wassertrüdingen
phone: +49 (0) 9832 6868-50
e-mail: info@jeremias.de
www.jeremias.de

POLAND

www.jeremias.pl

SPAIN

www.jeremias.com.es

RUSSIA

www.jeremias.ru

USA

www.jeremiasinc.com

CZECH REPUBLIC

www.jeremias.cz

UNITED KINGDOM

www.jeremias.uk

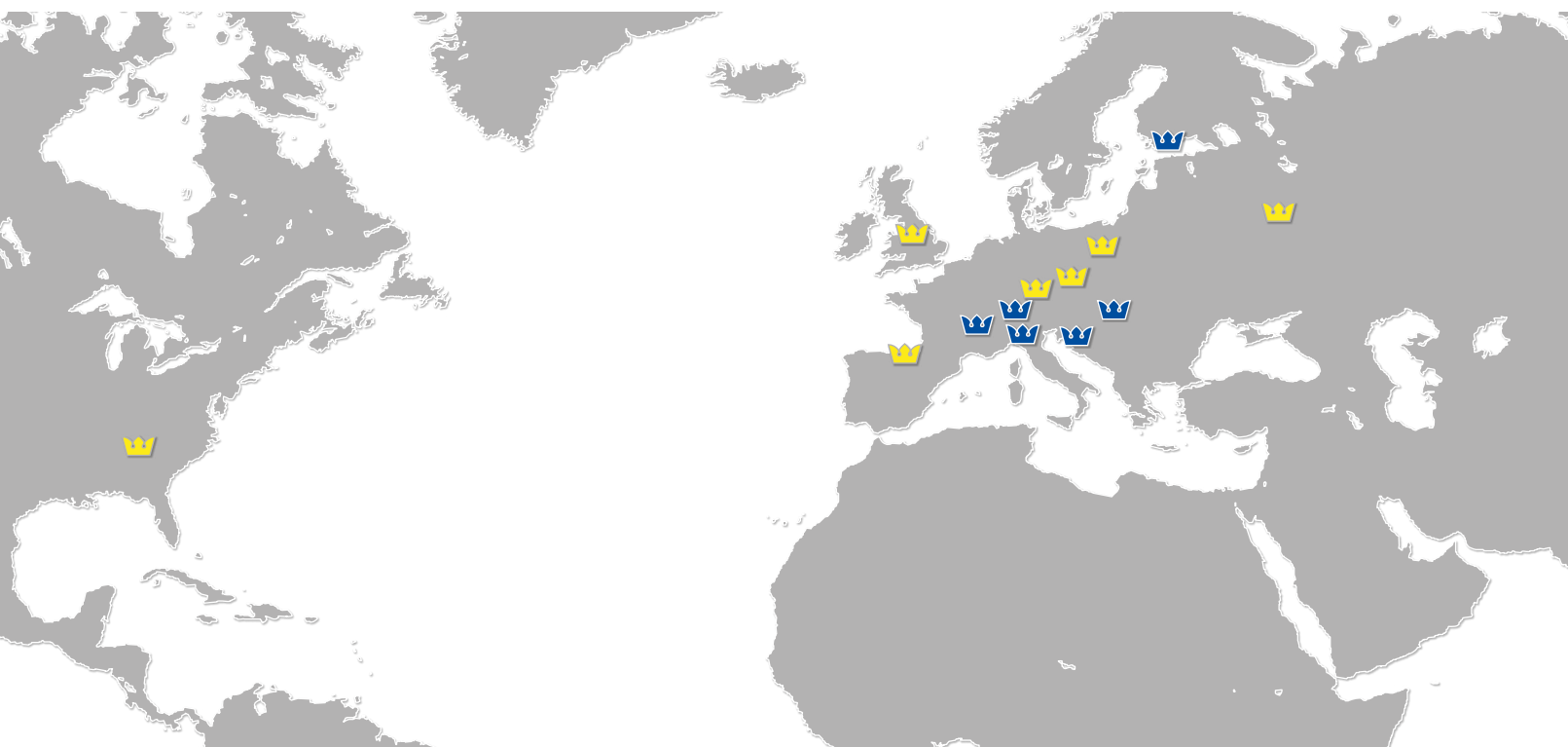

SALES OFFICES

FRANCE

www.jeremias-france.fr

HUNGARY

www.jeremias.hu

CROATIA

www.jeremias.hr

FINLAND

www.jeremias.fi

SWITZERLAND

www.jeremias-schweiz.ch

ITALY

www.jeremias.it

JEREMIAS IS REPRESENTED IN THE FOLLOWING COUNTRIES:

Austria | Belarus | Belgium | Bulgaria | Brazil | Denmark | Estonia | Hong Kong | Ireland | Kazakhstan | Latvia | Lithuania | Luxembourg | Malta | Netherlands | Norway | Portugal | Romania | Saudi Arabia | Serbia | Singapore | Slovakia | Slovenia | South Africa | Sweden | Tunisia | UAE | Ukraine

The expert in your area:

Jeremias high quality products to be installed only by selected experts.